

IRBY CC  
SPECIAL

WIRRAVE

» 325 «

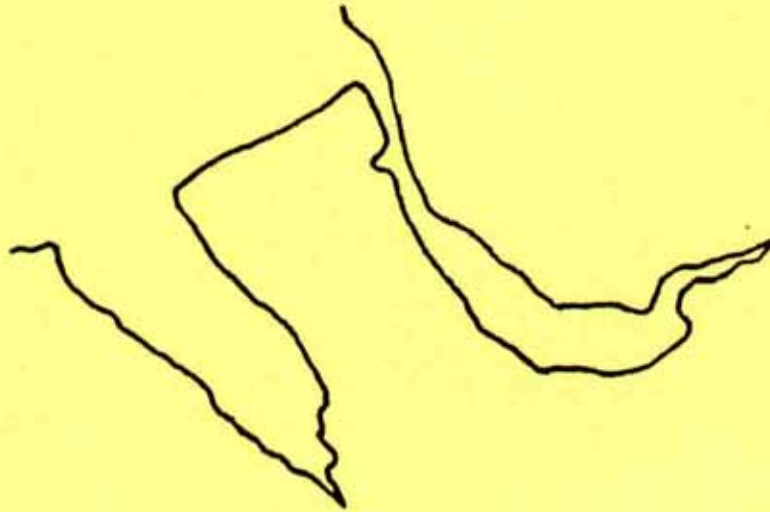

WIRRAL AND DISTRICT  
AMATEUR RADIO CLUB

G4MGR --- G8WDC

## CLUB EVENTS:

August - December, 1982.

- Aug. 11 KNOW YOUR NEW CLUB QTH.  
CELEBRATION EVENING AT IRBY CRICKET CLUB.
- Aug. 25 Junk Sale.
- Sept. 8 Sun, Earth and Radio. Part 1.  
Sept.22 Sun, Earth and Radio. Part 2.  
The theory and practice of RF Propagation throughout  
the RF.Spectrum, as presented by GORDON ADAMS.G3LEQ.
- Oct. 13 Advanced Driving Techniques.  
By FRED WELCH.  
President of Wirral Advanced Motorists.
- Oct. 27 Understanding Receiver PARAMETERS.  
JOHN FOGG. G8UZZ.
- Nov. 10 Activity Evening.  
Bring your Rig, Computer, Printer, Terminal Unit  
or whatever.
- Nov. 24 SOCIAL EVENING & PRESENTATIONS.  
Guest of Honour - BASIL O'BRIEN. G2AMV.
- Dec. 8 CHAIRMAN'S NIGHT.
- Dec. 22 No meeting due to Christmas.

- - - - -

OTHER DATES FOR YOUR DIARY:

- SEPT. 4th & 5th. 144 + SWL Contest.  
IARU 144 Contest.  
SSB FIELD DAY.
- Sept. 26 RSGB Region 1 VHF
- Oct. 2nd & 3rd. IARU VHF Contest.
- Oct. 14th - 16th The 11th ARRA at Leicester.
- Oct. 24 0100 hrs. GMT British Summer Time ends.

FOR FULLER DETAILS OF THESE AND OTHER EVENTS  
READERS ARE ADVISED TO CONSULT 'RAD COM'.

- - - - -

CLUB MEETINGS ARE HELD AT 8 p.m. ON THE SECOND  
AND FOURTH WEDNESDAY IN EACH MONTH. VISITORS  
ARE WELCOME.

IRBY CRICKET CLUB IS NOW THE VENUE. THE  
CLUBHOUSE IS JUST OFF IRBY MILL HILL ROAD, ON  
THE WESTERLY SIDE, ABOUT  $\frac{2}{3}$  MILE NORTH OF ITS  
JUNCTION WITH THINGWALL ROAD, IRBY.  
PLEASE PARK AT THE TOP OF THE LONG DRIVE AND  
WALK DOWN TO THE CLUBHOUSE.

A MAP IS ON THE BACK PAGE.

D & W's.

'D & W's' Stands for 'Drinking & Waffling' - The name that we give to the informal gathering of members and friends over refreshments at a pre-arranged local Hostelry. Most people arrive from 9 p.m onwards.

Aug. 4	Seven Stars.	Thornton Hough.
Aug. 18	Greave Dunning.	Greasby.
Sept. 1	Green Lodge.	Hoylake.
Sept.15	Primrose.	Liscard.
Sept.29	Victoria Lodge.	Tranmere.
Oct. 6	Hotel Victoria.	Heswall.
Oct. 20	Red Cat.	Greasby.
Nov. 3	Railway Hotel.	Meols.
Nov. 17	Wirral 100.	Oxton.
Dec. 1	The Harp.	Neston.
Dec. 15	Greave Dunning.	Greasby.

IT IS QUITE POSSIBLE FOR EXTRA D & W's TO BE ARRANGED AT SHORT NOTICE, ON ALMOST ANY NIGHT OF THE WEEK.

LISTEN TO 325.

-----

VISITS:

AUGUST - Wednesday 18th.  
GRANADA TV STUDIOS, LIVERPOOL.  
25-30 people. 6.30 p.m. start.

OCTOBER - Wednesday 20th.  
MERSEYSIDE COUNTY POLICE HEADQUARTERS.  
15 people max. 6.30 p.m. start.

SEPTEMBER  
HEAD POST OFFICE, LIVERPOOL.  
Details to follow

FURTHER DETAILS AND PLACE BOOKINGS :-

Frank Kneale. G4DBG  
Tel: 339 9623

-----



WIRRAL AND DISTRICT AMATEUR RADIO CLUB.

COMMITTEE:

CHAIRMAN.	JOHN FOGG.	G8UZZ	051	632 3131
SECRETARY.	GERRY SCOTT.	G8TRY	"	630 1393
TREASURER.	PETER REARDON.	G8WQQ	"	677 9561
CONTEST MANAGER.	(Vacancy )			
PUBLICITY MANAGER.	NEIL McLAREN.	G4OAR	"	608 1377
SOCIAL SECRETARY.	FRANK KNEALE.	G4DBG	"	339 9623
NARSA Rep.	PETER DENTON.	G6CGF	"	630 1467

- - - - -

'AIRWAVES' - IS THE PERIODIC NEWSLETTER OF THIS CLUB AND IS PUBLISHED THREE OR FOUR TIMES A YEAR, AS ARTICLES AND EVENTS DICTATE.

ARTICLES FOR INCLUSION, INCLUDING MEMBERS ADS, ARE ALWAYS WELCOME AND SHOULD BE SENT TO THE SECRETARY AS SOON AS POSSIBLE BEFORE PUBLICATION.

THE VIEWS EXPRESSED IN ANY ARTICLE IN THE NEWSLETTER ARE NOT NECESSARILY THOSE OF THE COMMITTEE. THE COMMITTEE RESERVE THE RIGHT TO WITHHOLD ANY ARTICLE FROM PUBLICATION.



This year has seen a marked change in the activities of our Club's Members, and the trend has been more to the Social side than to the serious side of Amateur Radio. O.K., we don't want to be serious all the time, but there are a few occasions throughout the year when most radio clubs want to put on a good Show in competition with other Clubs.

Basically, these times are in Contest Operation and at Rallies. On both of these occasions membership participation has been sadly lacking in our Club and the whole image that has been portrayed has been due to the hard work of a small group of members.

At Belle Vue we had the only unmanned stand. Why? Because nobody had brought anything to display, or to demonstrate, or simply to show off that needed to be watched.

The 144/432 contest was reasonably supported, but this, and other difficulties, meant that the station did not operate during the night, and the expedition to North Wales (Crooked Horn Pub) had a similarly poor turn out.

This has meant that contests that we, as a club, had planned to take part in, were not entered, despite numerous requests for volunteers. These were all VHF or UHF orientated contests, about which the membership should have more idea about operating than the HF bands or in CW contests. Meanwhile, a small group of our more enthusiastic Class A members are becoming more interested in working HF Contests on their own, if necessary.

So, with this edition of 'Airwave' members are being given the opportunity to have their say as to what they feel, or what they can do about contests.

Along with the invitation to a special celebration evening at the new Club Headquarters at Irby Cricket Club, there is a simple questionnaire to determine how you feel about the clubs participation in contests, if you can help please fill in this questionnaire and return it.

The BIG NEWS of course is our change of venue to IRBY CRICKET CLUB. All our members (except County members) have been accepted as non-batting members of Irby Cricket Club at the Club's expense (approx. £2 each) which is about what we would have paid in total to continue at the Concourse. The Council were going to increase rates anyway and impose an admission charge on entry, even though we had a 'block booking'. Our members will now be able to enjoy the same facilities at Irby Cricket Club as any other non-batting member, including bar facilities, and of course, will be bound by the rules of that Club also.

The rules of Irby Cricket Club are quite straight forward, and are commonsense really. Your attention is drawn to Rule 6 CLUB PREMISES AND BAR, which is reproduced in full at the end of the Magazine. At present we have only two copies of the Rules, and you would be advised to read them when you can. Please ask to see them.

Due to the structure of the subscriptions and entrance fee to I.C.C. it is important that to enable us to pay the correct rates, we enroll everybody in the correct category, i.e. Under 16; In full time education; Lady member; Under 65; Over 65. The entrance fee is the same for all non-playing members

To enable us to do this, we are experimentally amending our membership categories to bring them in line with the definitions used by the R.S.G.B. and this will automatically make it easier for us to enroll our members into Irby C.C. in the correct category. At present, we are asking new applicants to fill in a revised application form so that we can gain experience and produce a suitable package for proposal at the A.G.M. in January. The Committee feel that an experiment on these lines is alright, but to make a permanent change



of the proposals later in the year. Both Committees look forward to the move and hope that a long and happy association will evolve.

On the subject of our Committee, we have to announce that Steve Eyre tendered his resignation, which was accepted, earlier, this year. Steve only tentatively accepted the post, due to a possible change of outside commitments. These changes did take place and we wish Steve the BEST OF LUCK.

In his place we have unanimously appointed Frank Kneale, G4DBG to the Committee as Social Secretary (visits etc.,) Frank was only one vote behind Steve in the ballot at the last A.G.M. and the fruits of his efforts have already been seen.

The barbarque at Heswall once again proved very popular despite an initial slow response to names of those who were coming. Our thanks go to Frank DBG for organising it, his wife Heather and to Elaine (XYL of 'Try) for the cooking. John 'UZZ provided lighting, Richard ('NDD) who aquired the hearth from his neighbour and not forgetting Steve ('TCC) for once again providing transport. Also Colin ('RLA) for tidying up and removing rubbish. About 30 people attended and the occasion was enjoyed by all.

NEARLY FORGOT TO TELL YOU.....

The November Social has Basil O'Brien, G2 AMV, as guest of honour. We are also planning a DINNER DANCE later in the year, in addition to the Social. We have a few locations in mind, but Frank 'DBG, would be pleased to hear your comments.

At the time of writing, I hear that the May RAE results are out. Congratulations to all of you who have just passed, and the best of luck to those who are going to take it again.

Readers will be pleased to know that Dave Owen has now made a full recovery from his recent ill health, and is now back at work.

November 10th sees our first activity evening. The object is to bring along some gear and to try to get out on the air, by using various equipment connected to rigs such as computers and RTTY. Bring home made or commercial gear, show it off, have a go on (or at) somebody elses gear - try it out - talk- drink - and then try to get the Club's masts down in the dark!

So far, we have three visits planned. We also have ideas for other places as well, but we are always pleased to have your suggestions. However, I must emphasise that there limits to the size of parties, and to go on one you must first book with Frank, 'DBG, on a first come first served basis.

Preserved busses now have quite a following within the club now. Listen to .225 (S 13) for the latest in the news on '668' or '56'.

WANTED!— ANOTHER NEWSLETTER BEFORE THE  
NOVEMBER SOCIAL — WRITE YOUR ARTICLE NOW  
OR IT WILL SOON BE TOO LATE TO BE INCLUDED.

ATTENTION ALL YAESU OWNERS :-

Recently, a committee member was looking inside a Yaesu FT480. In various places there are stick-on labels, all bearing the same number, in red ink. This number is very similar to the set's serial number, but it is different.

Subsequent investigation amongst other FT480 owners revealed that they, too, have a numbered label inside the set. The red labels are always the same number within any given rig, and always different from the rig's serial number to be found on a metal plate underneath.

For example, serial No. 1C 090174 Red Label 090222. On the '480, the easiest way to read the number on the red label is to remove the right-hand channel for the mobile mounting bracket, retained by three screws, which is located along the side between the upper and lower covers, and is made of black anodised extruded aluminium. You are advised to make a note of the number, together with your serial number, and any other distinguishing features (dents, mods, etc.) in case your rig is stolen and is subsequently recovered. Remember, the serial number may be removed or altered by a thief.

This information is based on the case of a Yaesu FT480, but probably holds true for the '780, and possibly other Yaesu equipment, or even that of other manufacturers.

Therefore, would owners please check their rigs, and if similar cases come to light, then we would be pleased to print them in the pages of this magazine.

N.B. PYE owners can find the serial number of their equipment by looking at the chassis where it will be stamped (in the case of Rangers, Cambridges and Westminsters), or engraved on the PCB (in the case of Pocketphones).

As the label carrying the serial number also carries the original frequencies, it is not unusual for the label to be removed when the equipment QSY's on to amateur bands.

\*\*\*\*\*

AMATEUR RADIO MAGAZINE

Regular browsers at the newsagents may have noticed a new magazine appear during June, entitled "Amateur Radio".

The magazine provides a very good insight into the many facets of amateur radio, how it started, how to get a licence, typical rigs, etc. In fact, most of the things that a licenced amateur would already know, and often gets asked by newcomers, are covered in it. Priced at 90p, it gives no indication as to when or if, the next edition is due out. It is perhaps not the sort of mag. that most of our members would buy, except for information that they already should know, but it could be useful to have to lend out to an interested friend.

The only mistake to come to light in it so far is that in one article it refers to the RSGB as the "governing body" in this country. Of course, the Home Office is the governing body, and the RSGB is the national society that represents all amateurs and short-wave listeners in this country.

A.R. editor, please note!

Amateur Radio's team appear to have no connection with any other radio or electronics magazine, and its content is therefore quite impartial.



## GOING ONCE, GOING TWICE.....

The firm of B. Bamber Electronics will be familiar to a lot of readers, especially those who have sought a source for PYE spares and diagrams. They used to advertise in a lot of radio mags., including RAD COM. About 18 months ago, they decided to greatly reduce their interest in PMR equipment in favour of CB gear. Advertising in our radio mags stopped and a lot of spares were sold off cheaply.

At the same time they started to hold auctions of gear on a regular basis. every one or two months at the nearby East Anglia Auctions. Equipment to be sold including PMR equipment, spares, components, test equipment, electronic equipment and office furniture in various sized lots. A catalogue of lots is sent out in advance and postal bids are accepted.

Your Secretary, Gerry GSTRY, is on this mailing list, so if any of you are interested in bidding at auctions for any of this equipment, get in touch with him and he will let you have further details and make the lists available to those seriously interested, as and when they are available.

Incidentally, for whatever reason, Bambers are now advertising again in RAD COM in their usual way.

THERE WAS A COPPER FROM CLAUGHTON  
WHO HAD A BIG WHIP AND A SHORT 'UN  
AND NOT ONLY THAT  
HE HAD A WHITE HAT  
AND A RIG ON HIS 850 NORTON.  
+++++

## LATE NEWS!

Since writing this, Bambers are to stop sending out free catalogues and are to charge 60p each. Their letter is reproduced to the rear of this mag. It also gives auction dates.

Pat McDonald, an Irish farmer, has put forward a proposal for a new Southern Irish repeater, to be run on pig manure. The proposed callsign is EI EIO.

Heard on EI 1 DK Repeater:

"CQ CQ CQ Contest"

(From "QSP" IOMRS)

Last year, due to popular demand, the North Wirral College of Technology (Birkenhead Tech. to you and me) ran two RAE classes. This year they expect to increase the number of students in the course yet again.



D.F. HUNT RESULTS:

The D.F.Hunts were very well attended this year, once again, and teams do seem to be improving. If more people acquire electronic D.F.equipment, we could possibly hold a special section in the D.F.Hunt. In the meantime the idea of a Sunday D.F. Hunt seems popular before the weather starts to get a bit cool. There are problems if you want to go for a drink afterwards, so have a 'think' about what you would like and let us know.

The EILEEN MEDLEY D.F.HUNT -

Official start delayed by 8 minutes. Fox in Mersey Park.

Finishing times (local times)

9.06 G4OAR G8TCC G6IIM = YL

9.22 G6IFX

9.32 G6AGP G8MMM G6ADO G6HGI

9.37 G8NOM with Karen and Jenny.

G6IAD G8WOL and G6HKY also found Fox - after time.

REVENGE D.F.HUNT. 8.00 Start. Fox in the Arno, Prenton.

Finishing times

8.36 G8TRY G8TSE G4DBG

8.44 G4DLY

8.48 G8UZZ G4NOY G6HOX

9.00 G6IFX

9.25 G6HGI G6AGP G8MMM G6ADO G4BKF

The proper winner was G4DLY as the G8TRY team started 15 minutes late. Other teams were not on site by 7.50 and strictly not within the rules. The rules also stated not more than four persons in one team. But the event is run for fun, so no prizes and everybody enjoyed themselves.

Come home to a real fire -  
 BUY A COTTAGE IN CLWYD.  
 ++++++

#### Visit to GD Land:

During June, I spent 9 or 10 days on the Isle of Man, most of which were very wet. However, despite not being able to visit all of GD land's beauty spots (again), I did manage to work /M and /P from some high spots, in the car, and I paid a visit to the Isle of Man Amateur Radio Society at one of their meetings.

They meet every Monday at the Keppel Hotel at Creg-ny-Baa, a small town on the TT course to the North of Douglas. This is a good site for HF and VHF and, in fact, they have HF and VHF aerials located permanently at the rear of the hotel. Every other meeting is an Activity evening, involving activity on the air (HF and VHF), morse, training and Home Brew projects.

So, if you want to work GD4IOM, point your beams to the North West and take a look around the CW and SSB part of 2 metres, or on 80 metres, on Monday nights.

By the time I arrived on that Monday night, a lot of time was spent talking and listening for VP8's who had just come back on the air from the Falkland Isles. GD4IOM had closed its log for the night by the time I got around to the 2 metre station, but the owner of the TS780 did allow me to use his rig before we got thrown out of the Keppel, so I put out a call on S.13 and signed /A, to work some of the "locals" on Wirral, with good results. (Somebody said it was the rig's first time on FM, because it was so new).

I spent a lot of time talking to John, GD4MNS, both in the clubroom, and afterwards in the carpark. John is one of their committee members and produces/edits their newsletter "QSP", a very creditable magazine, with a high content of articles written by club members. Many thanks to John for letting me have a copy.

One of the big problems for the club on the Island is finding guest speakers, as no-one can really expect firms and organisations to make the trip over. However, a useful source of income comes from overseas visitors, particularly the Americans, who join the club whilst on holiday.

Incidentally, the GD stations do use 2 metres FM, usually S16, or even S20 if it's quiet, for local chats. Unfortunately, I was unable to confirm the rumour that the squelch control is always turned up high.

If anybody would like to see the "QSP" newsletter from the I.O.M.A.R.S. please let me know.

GERRY GÖTRY



THE EILEEN MEDLEY D.F. HUNT. - The Fox's View.

The Club held its Annual D.F. Hunt for the Eileen Medley Trophy on Wednesday, 30th June. As is not unusual, the best laid plans had gone wrong, and I found myself without a "fox" at 5 p.m. the day before. After some 'phoning around in the evening, I still had no fox at 9.30 p.m., so it left no alternative but "do it yourself".

It so happened that one-third of my team, in the shape of Peter 'CGF', couldn't make it anyway. I only found that our on Monday nights. So, another quick 'phone call, this time to Frank 'DBG', the third member of the team, meant that we were still taking part in the contest, but we were going to be the 'fox' instead of the 'hunters'.

Neither of us had had any previous experience of being the fox, and of course, a suitable 'lair' had not been investigated. Then I remembered a site that I had once used to take a bearing might be suitable. This was Mersey Park, in Birkenhead. I just hoped that I hadn't mentioned it to anyone before!

Most people in our club either didn't know it existed, or had forgotten where it was when I mentioned taking a wrong bearing from there. (That was when Malcolm was the fox at Eastham Ferry and my HB9CV gave a very definite heading into New Ferry). The reason, of course, must have been due to reflections, thus making it a good place for a lair. Around the park are blocks of flats, a water tower, the sheds and cranes at Cammell Laird's, and the Shell oil tanks in Lower Tranmere.

But what about getting the R.F. out to Heswall? We had no chance to try it, and a check of the O.S. map showed that we should first miss the higher land behind St. Catherine's hospital, with only buildings in the way before the Storerton Ridge and then up the hill to the Woodchurch. O.K., we could probably do it, but we would need more than 3 watts for a decent signal.

Therefore, a small linear amp was needed, plus a car battery, plus aerials and feeder, and headphones. These were all available, but crocodile clips to suitable sockets had to be made up to suit those I'd fitted to the amp, and for the rig if the nicads should run out on either of the portables we would take. This meant that I was making up leads and sorting out adaptors etc. at about midnight the night before!

Also, I needed a "Hunt Organiser" to take the names of the teams starting at the lay-by, and this was soon arranged with Niel over the air. Then a quick check of headphones, linear amp and slim Jim showed that all were working o.k., so it was off to bed at about 1 a.m.

The following evening, Frank came with battery and his IC-2E; we loaded up and set off for the park in Frank's car because it has no signs of amateur radio on it. On arrival we had to choose the spot for the lair: we chose behind the bandstand, but the cricket clubhouse and gents' toilet were also considered, and we set up the gear.

Initial contact with Niel at Heswall was made at about 8.03 using a rubber duck because of being too weak on the slim Jim. Therefore, the amplifier was fitted and aerial moved around a bit. Still very weak but not as bad. A quick check of the power and aerial leads revealed that the ~~power~~, solid



conductor had broken off on the tapping point on the Slim Jim, and this was quickly put right. At 8.08 the 'fox' officially began his transmission using about 25 watts; however, some teams had already moved off but there was not much that could be done about it, and no advantage would have been gained.

When the initial transmission had been sent we soon discovered a major problem. We'd forgotten to bring any cans of refreshment! This was quickly put right by sending Frank down to the local off-licence. Later on I was wishing that we had chosen the gents' toilet as the lair.

All the usual transmissions took place for taking bearings until I suspected, wrongly, that somebody was close to us, so it was on with the headphones with boom microphone. They worked well at first, and then they started cutting-off. At first I thought it was a broken wire but it turned out to be a faulty switch.

We were very pleased to have the first team find us in just over an hour, with two more within the next 20 minutes. The fourth team found us just on finishing time at 9.38, precisely 90 minutes from the initial transmission. A further 3 teams found us with a lot of help from the fox within the next 15 minutes.

So, we all packed up and went to the QSY at the Victoria Lodge to discuss the event. There we found, much to our surprise, some previous winners who had not found this fox on the night.

I hope this article demonstrates what fun it can be being a fox, and explains that some of the fox's tricks were far from deliberate.

Many thanks to those who took part, especially Phil and John, who travelled over from deepest Cheshire, and our own John 'UZZ', for making the round journey to and from Stone in Staffs, while on a training course.

G8TRY

\*\*\*\*\*

### 88 and 73

The numerals 88 and 73 have been a tradition in communications language for almost 120 years. The older of the two - 73 - appeared in 1853, meaning "My love to you". In 1857 the first official definition made it "fraternal greeting between operators". Two years later, 1859, Western Union made '73' a part of their 92 Code to indicate "accept my compliments"! The final change came in 1895, when 73 meant "best regards" for the telegraph and later for radio operators.

88 never received the formality of an official listing until it was adopted as one of the "Ham Abbreviations". It has been one of the telegraph operators' traditional terms since well before the turn of the century. During the First World War, "88" was used by the U.S. Army Signal Corps., again strictly as an operator's abbreviation in unofficial communications. At the close of WW1 "88" achieved official status as a part of amateur radio terminology "love and kisses".

There is no plural to 73 and 88.

MERSEY TUNNELS RE-VISITED

Readers of the Spring edition of "Airwave" may recall that I said that the first new automatic booths at the tunnel would come into operation about the end of March. This obviously hasn't happened and the latest estimate is that the first six new booths will become operational at Wallasey during August. Within six months the conversion of both tunnels should be completed. When this happens then the magnetic card readers can be phased in to replace the pre-paid ticket scheme.

The reason for the delay is that the designers and manufacturers, ARC, were let down by their suppliers. Also, it was decided to provide a modification to improve the security of the cash collected.

Many of you will also have noticed the scaffolding around Georges Dock Building. This building is being refurbished, apparently just in time, as some of the masonry was in danger of becoming loose and falling to the ground.

Also planned for refurbishment in the near future is the whole of the Birkenhead tunnel, Queensway. Work is expected to start in the New Year on completely re-lighting the tube, at a cost of £1.1 million. Fluorescent lights with reflectors placed centrally in the roof will replace the original 50 year old 25 watt fittings in the walls.

In conjunction with the lighting project, re-surfacing of the carriageway will also be carried out at a cost of £0.5 million. The existing surface which replaced the original metal sets, will be removed and replaced by new material throughout.

It is expected that this work will take in excess of three months. The re-surfacing should be completed first, and the work will be carried out at night. This will involve closing the Birkenhead tunnel from 9.15 p.m. in the evening until 5.45 a.m. in the morning. Special diversion signs will be erected, of a flap type, and will be left permanently in position. This is so that should any future closures be necessary, the diversions can be quickly set up. Flap type signs were chosen due to the high incidence of vandalism to electrically operated signs, and for cheapness.

Motorists are advised to use extreme caution during the re-surfacing period as sections of carriageway are likely to be grooved after the previous night's work, and the sections will vary on a daily basis. For the same reasons, motorcyclists will be advised not to use Queensway at all. Special arrangements will be made for cyclists during the closed periods.

Unfortunately, visits to the tunnels are not available.

\*\*\*\*\*

Q : What do you get if you clean a smoothing condenser in alcohol?

A : A paralytic capacitor.



RADAR GUNS.

RADAR speed trap guns have always been a source of controversy. Not all the Police forces are happy with the use of the guns either, although they have often been the main evidence in prosecuting hundreds of thousands of speeding motorists in the past ten years.

These doubts have led to ten police forces rejecting the use of hand held guns in favour of existing equipment. These police forces include Merseyside, Lancashire, Gwent and Derbyshire.

Currently there are over 300 guns of three different makes in use in this country, all imported from America or Canada. They are known as the MUNI QUIP, KUSTOM and the MPH K15. The guns work on the very accurate doppler shift method. A radar beam is sent out to a moving object and the reflected signal back to the gun changes frequency in proportion to the speed of the object. The gun computes the frequency shift into speed and displays the result to the user.

However, despite the accuracy of the system, there are at least five different ways in which the guns can give false readings. These are, low batteries, poor electrical contact in car lighter sockets, reflection of the beam off metal objects, reflecting off another moving object and radio interference.

The AA feel that there are insufficient safeguards built into the guns to protect against radio interference. The source of RFI may come from hundreds of meters away from the gun, in any direction and the operator of the gun is, of course, completely ignorant of its presence. The short duration of radio transmissions and the random movement of mobile radio stations renders it impossible to devise a reliable test for RFI.

The manufacturers and distributors of the Radar Guns are becoming aware of these problems and are modifying this equipment and instruction manuals in the light of experience. One manual gives a warning against siting the device within a quarter of a mile of a powerful VHF radio or UHF TV. Transmitter; within 100 yds. of high voltage overhead power lines; near large rotating fans or signs; near large rotating radar or within 30 yds. of smaller transmitters. Unfortunately it appears that not all the police forces using the guns have taken advantage of the distributors training packages or advice. Both the AA and BBC TV have brought cases of poor training to light and the Home Office has been given details, but has constantly said that its only concern has been the effect of RF emitted by the guns. The H.O. consider the guns to be well made and up to standard for Police use, but use the old story of staffing and finance as an excuse for Home Office Telecommunications not to undertake any further evaluation of devices brought to their notice.

The police themselves are looking to have Home Office approval of devices, rather than a British Standard. They are very concerned that they are seen to do their job properly.

Footnote :-

While the licenced use of Amateur Radio equipment is to be encouraged, we would not like to suggest that calling out 'CQ 2' or something similar while going through a radar speed trap, could be used in any defence against a speeding conviction. Indeed, it could also lead to a charge of driving without due care and attention if you are using a hand microphone.



GOOD BUDDY, YOU BREAK ME UP. (A CB Saga!)

1982, the year of the overtime cutback, a squad of eight weary and careworn British Telecom engineers, converged on a small chapel, now a converted radio store.

From their midst stepped a young engineer, Wally, his body shaking with the effort of getting out of bed. In his hand he held a No.4 screwdriver and a small cardboard box. "Come to fix your bleeding phone" he muttered politely to the owner.

The owner fell to his knees in supplication. "My good Buddy, I knew some day the Lord would hear my D X transmissions. Maybe he'll send me a QSL after matins. Come in and rest a while." He took Wally to the storeroom and left him. Peace was now in his heart.

As the day passed, the owner now desiring to go to his home 20 crept into the room to discover Wally with a pack of cards, and his head reposing on a Midland 2000 (Home Office Approved).

"Young Man" the owner said "I must see that your overtime and subsistence is ceased". Wally turned ashen at the thought of losing his beer money.

"My Dear Good Buddy" he said, "I was just resting before my labour; you see, kind sir, this pack of cards is really my CB bible, carried with me through a tortuous campaign at Newby Bridge, Coniston and the dreaded Langdale.

"The 2 reminds me of the two switches. Off and On, always decisions to make.

"3 is for the three wise good buddies 'Nimrol', 'The Governer' and 'Whiskey Mac' always modulating.

"On channel 4 it is great fun sending Ambulances round in circles. How the drivers love the overtime we give them.

"Channel 5 was promised to the wife at Christmas, she was very surprised when I handed her the mike.

"Six reminds me of what I've missed, since giving her the mike instead of what she expected.

"8 of spades reminds me of the eight good buddies who fetched me here, still arguing in a layby about who should brew the tea.

"Nine Office Staff give me heavenly guidance on my duties every day, one yes, one no, and seven dunnos.

"The 10 code fetches back memories of tea breaks every hour, but higher management decreed that 10 was no longer to be a tea break, coffee instead.

"For four hours I transmitted into the heavenly skies, nobody answered, had the almighty forgot me, I thought. No, not him, I still had the Jack in my hand.

"A queen of hearts was my wife, but she left channel 2 open one night and went off with Slippery Sam. He was a good buddy. I will miss his transmissions.

"King stands for ruler, but my wife laid down rules when she heard Yellow Sal telling me to go up a bit higher. If only she hadn't been sat on my knee. Ah well.

"Finally, the Ace, a top and bottom card, heaven and hell, FM and AM. Young bucket mouths at the bottom with older ones at the top.

"That, my friend" said the young engineer, "was the CB deck of cards, my life, my dreams, my bible, and the cause of my divorce".

With a tear in his eye, the owner put his arm around Wally's shoulders. "Good Buddy" he said, "in every packet there is a joker. You see, I'm not a shop owner but a store detective and that is a base aerial stuffed up your jumper. Finish your cocoa out of that brown bottle, grab a red grouse bun and we will burn rubber to the smokies home."

"Oh, goody" said Wally, "can I play with their intercoms and twiddle their knobs?".

Wearily, the detective, once a sky diver, looked towards heaven. "You are now on night rate, Wally. It's 10-10, the end of your transmission".

FROM A POEU JOURNAL.

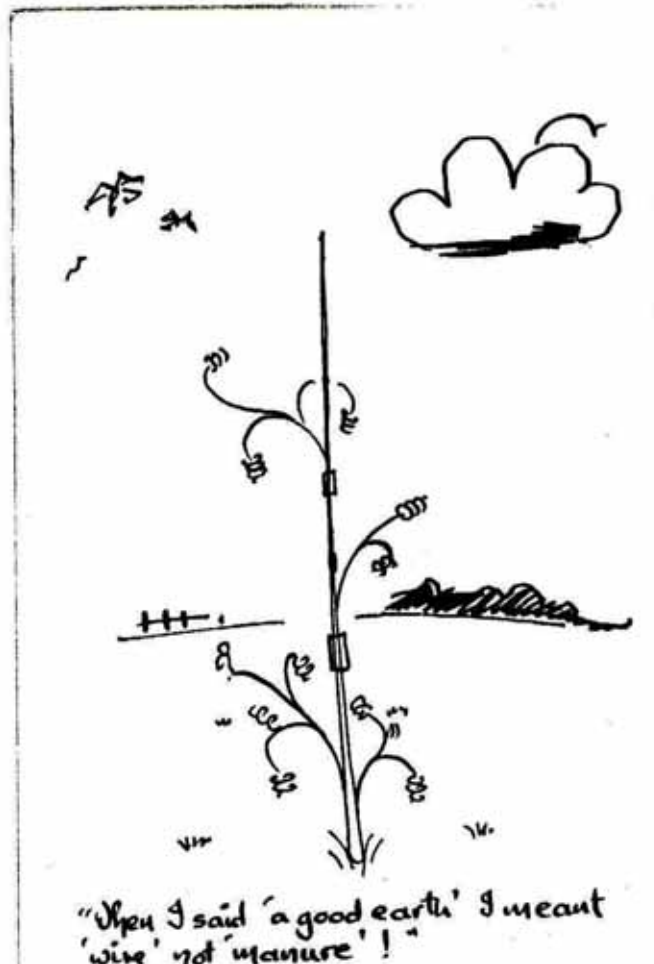

THE NEW DAWN

The tall young man gazed out of the restaurant window, as Liverpool's night sky line travelled slowly by, the revolving diners seemed to enjoy the tranquility high up above St. John's market, his own wife and son and daughter laughed gaily, all was well with the world, thought he.

A gentle bright sunrise in the west caught his eyes, 10.00 pm that's strange, BANG BANG:- Suddenly steel shutters replaced the windows, cutting out all outside view. The whole tower quivered gently amid the thunderous clanging of alarm bells.

As the noise subsided into a steady mutter of background noise, a hidden speaker crackled into life and a voice announced, "All Diners will lie flat on the floor, feet pointed inwards. This is an emergency lift-off position, and do not move, or you will die." The whole floor inflated like a huge cushion.

For below some people saw the bright light, others watched in awe, as the concrete cladding fell away from the tower to reveal the huge 3 stage rocket with the orbit station shining at the top, in the very brightening sky.

One single bell rang, and all around the base of the rocket plumes of smoke swirled outwards, 7,6,5,4,3,2,1, zero. The very earth shook violently as the whole of the silver pencil rose steadily into the sky, upwards ever faster the station rose, far below the place from where the rocket came, all buildings, people, cars, in fact everything melted in the intense heat. The earth was no more.

On and on past this galaxy and that galaxy the station travelled.

Bang the tall man's knife slipped to the floor, "Where were you John?" his wife asked as he bent to pick it up, hardly daring to look he watched the Liver Building slip by the window, and the moon shone on the river, "Just a dream, dear" he replied. "Just a dream."



QTH CORNER

CLIVE REDFERN - G4CZR

is now living near Ashford in Kent.

ROBERT WHITFIELD - G8TSE.

has moved to another part of Wallasey.

JIM - G6KJF and NORMAN ELSE - G4JGP

have moved to Rock Lane West in Rock Ferry.

GRAHAM STARKIE - G4LMJ.

should be going to the University of Sheffield for four years  
(A levels permitting) later in the year

MIKE AND JANE HOLMES - G8MMN and G8SFS

are expecting to move to Yorkshire later this year.

\*\*\*\*\*

Further details as available from the Secretary, G8TRY.

ARE YOU QTHR WITH THE CLUB'S RECORDS ?

Have you moved house or job, got a different phone number, or got a  
new callsign since May last year ?

IF SO - LET US KNOW.

**Peter Denton, G6 CGF.**

**is now back at his old house in Trafalgar Road, Wallasey.**

## TONE BURST CIRCUIT SUITABLE FOR A PYE CAMBRIDGE.

The circuit shown below is suitable for use in many rigs without a tone burst. Suitable connections are shown for connection to the FM10D, but constructors should have no problems adapting the circuit to work in any equipment.

The transistor and zenner diode ensure reliable operation on supplies from about 7.5v upwards. The 1750 Hz tone is set with the 2k pot, and the output level to the microphone is set on the 470k pot. The 555 linear I.C. produces the tone for approx. 0.5s after the supply is initiated, and then remains silent, drawing little current.

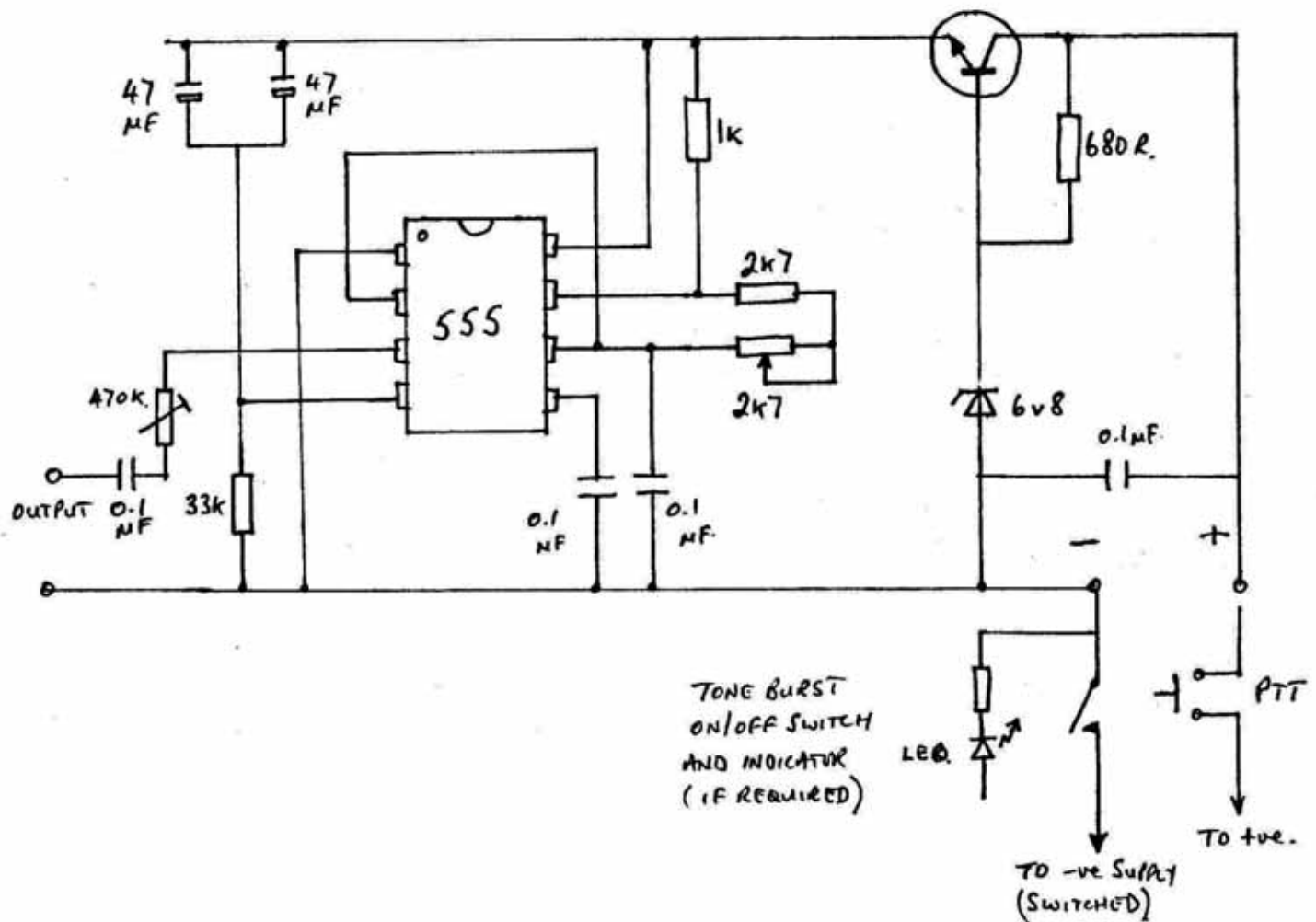



TIGHTER CONTROLS ON PRIVATE PHONE SALES.

GREEN FOR GO! RED FOR NO!

Tighter controls on the sale of telephones through private shops have been announced by the Government.

All telephone apparatus sold in Britain from November will have to bear a special label indicating that it has been officially approved for connection to the British Telecom public network.

Green for go. Red for no. They're the government marking orders. Approved equipment will have to carry a label with a large green circle while non-approved apparatus would be marked with a red triangle.

The marks must be clearly visible on the outside of the apparatus, so that buyers can easily see which are approved. A detachable label may be used, provided a permanent mark has also been placed in an unobtrusive position.

Many items which will bear the official prohibited mark from November will have been made to the standards of other countries, or to no standards at all.

British Telecom will be entitled to disconnect non-approved equipment and may withdraw service from a subscriber who refuses, but there will be no legal penalty for the offence.

From December all forms of advertising, except Telecom ads in telephone directories, must carry a statement of approval and show the appropriate symbol.

Testing and approval of telephone apparatus will be done by the British Approvals Board for Telecommunications (BABT), a body, completely independent of the government and British Telecom.



"'Get a job' she said 'it'll keep you off the streets'."

HEARD ON THE REPEATER.....

"I'll turn my pre-amp on, so you'll get a better signal from me !!"

+++++

It is understood that a certain carpet manufacturer will shortly be offering a special Amateur Radio Carpet impregnated with liberal droppings of solder. We understand it will not be more expensive than the home brew carpet.

For further information, contact IQ Zero (no call signs please) through nearest repeater.

(Thanks to Thornton Cleveleys Amateur Radio Society).

+++++

### I.Q. Zero's.

Do not recognise a jammer in any way, even with a short comment or in code. They also know the code and will persist with their interference.

If you can't make the QSO, sign out with an excuse and explain at a later date.

+++++

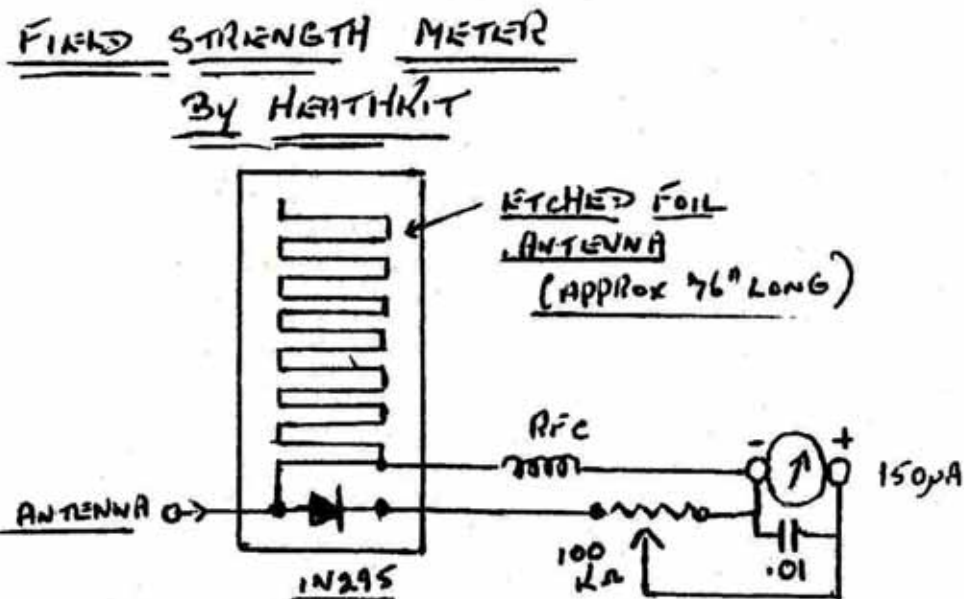

FREQ RANGE 1.6 TO 250MHZ

## RADIO AMATEURS EXAMINATION

Contratulations to the 36 people who passed the May examination at Borough Road, and the best of luck in the next series to the 11 referred students who only have to resit one paper.

Nationally, 8,500 students entered for the May examination and some 6,000 passed - just wait for all those new licences on 2m,. The examination will be held on Monday 6th December 1982, and the cost is £18.60, enter before 10th October, results January/February.

There is an extra examination next year on Monday 21st March, cost £18.60, enter in December - marking entries very clearly SPRING SERIES.

The main examination is as usual in May, 16th May 1982 and the cost is £18.60 (£14.60 if you study on the college course) enter in early January.

The course at Wirral Metropolitan College (alias Birkenhead Tech) costs £27.80 (20p if your unemployed or under 18 on 1st September - half fee if an O.A.P.) It is intended to hold the course on Thursday evenings 6.30 - 9.00 p.m., but if you cannot make it on Thursdays' it may still be worth your while to drop the course tutor a note at the college in case its decided to run a second course on another night or even afternoon. Enrolments are Tuesday 7th, Wednesday 8th and Thursday 9th from 10.00 a.m. to 8.00 p.m.

## RAYNET

Since the last newsletter there has been some developments on both the local and national fronts.

Digger Digby G8DHQ the Zone 10 representative for RAYNET has resigned and GMC and Wirral Raynet proposed Mike Oldham, G6DDQ the Bury Raynet Group Controller to be the new representative. He took over from Digger last Sunday.

Locally at a meeting of all Raynet controllers up at Lancaster University attended by G8PMW and G8RXB on behalf on Wirral. G8PMW is now the Merseyside Couty Controller, this was done to aid the formation of a Liverpool Raynet and to provide a administrative link for the R.S.G.B.

Several meetings of the Wirral Raynet group have been held as well as two exercises, no apologies for the surprise callout. The net night on S8 at 8.00 p.m. on the 10th, 20th and 30th of each month is not very well supported but is enjoyed by those of us that remember.

Any volunteers to help cover the Bolton Marathon on 22nd August?

*Gen. J. Brooks*  
G8PMW



NARSA REP'S REPORT

P L Denton G6CGF

The last Belle Vue was not a great success, however despite the fact that not one item was supplied by club members a stand was erected and covered by a good range of Photographs and QSL CARDS. Many questions were asked by visitors.

Many thanks to Steve G8TCC who provided the transport of the stand to and from Belle-Vue, and Gerry G8TRY who built the stand with me.

However:- Next year a new venue of the NARSA EXHIBITION:- A 2 day event, that should appeal to all club members whether single or families.

I have put a copy of the new venue advert in Airwaves, so lets have a good show next year. Any time around Xmas., I will build a stand in my house, so please lets have anything you can, i.e. models, old rigs, infact anything you would like to put on show, "Nudes excluded" unless accompanied by a great grandfather, or committee member (wifes permission needed).

Thanks to all members in advance.  
Peter Denton

Note to SLIM JIM BUILDERS.<sup>\*</sup> From G6CGF

If you use plastic tube (like drain pipe material), when you put it over a wooden dowell, leave a length of wood that is tapered (see sketch) do not leave a squarley sawn end. This will prevent kinking at the point of pressure change, when bending in the wind.

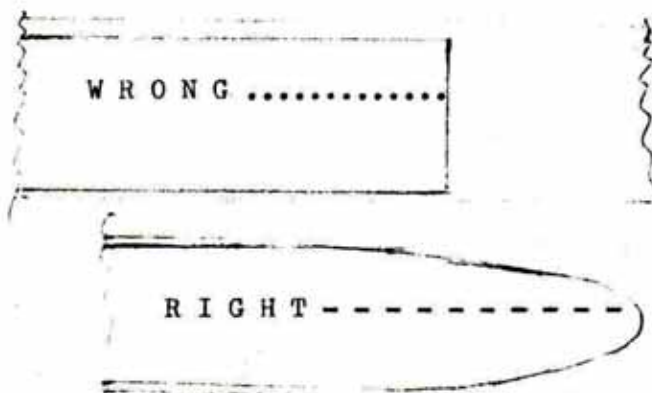

\* "Heard on 2m" (voice recognised) whilst discussing the above fault.  
\* "WHY NOT USE A METAL TUBE" "how's that for a sharp remark?"





Northern Amateur Radio Societies Association

# EXHIBITION EXHIBITION EXHIBITION '83 EXHIBITION

1982 sees the departure of our exhibition from Belle Vue and next year we will be at

## PONTINS HOLIDAY VILLAGE SOUTHPORT

---

***On Saturday 19th and Sunday 20th March 1983***

---

In addition to the usual facilities (Restaurant, Bars & Snacks) we are expecting family and childrens entertainment

Excellent catering facilities and overnight accommodation will be available at very reasonable rates. Full details later.

Make a note in your diary **NOW** to ensure you do not miss Britains first Ham-Fest, which promises to be

**THE RADIO EVENT OF THE YEAR**

.....

Please return this slip WITH S.A.E. if you would like further details re accommodation as and when available.

YOUR ADDRESS.

.....  
.....  
.....

RETURN TO: F. Smith G4GOM  
20 Gulseley Close,  
Walmersley,  
Bury.  
BL9 5JR



HB9CV

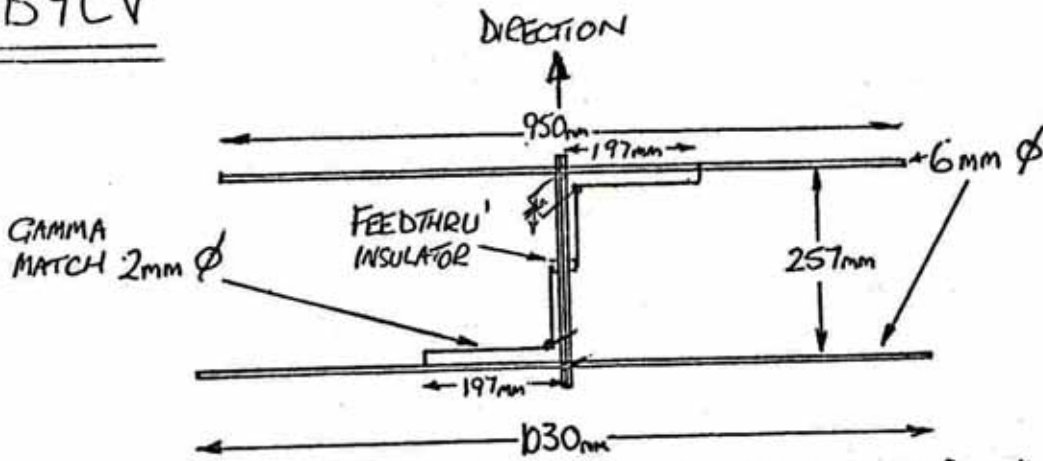

GAMMA MATCH SPACED 4mm FROM ELEMENTS  
 FEED WITH 50-75-Ω COAX ACROSS THE 2.5-20pf TRIMMER

ATTENUATOR.

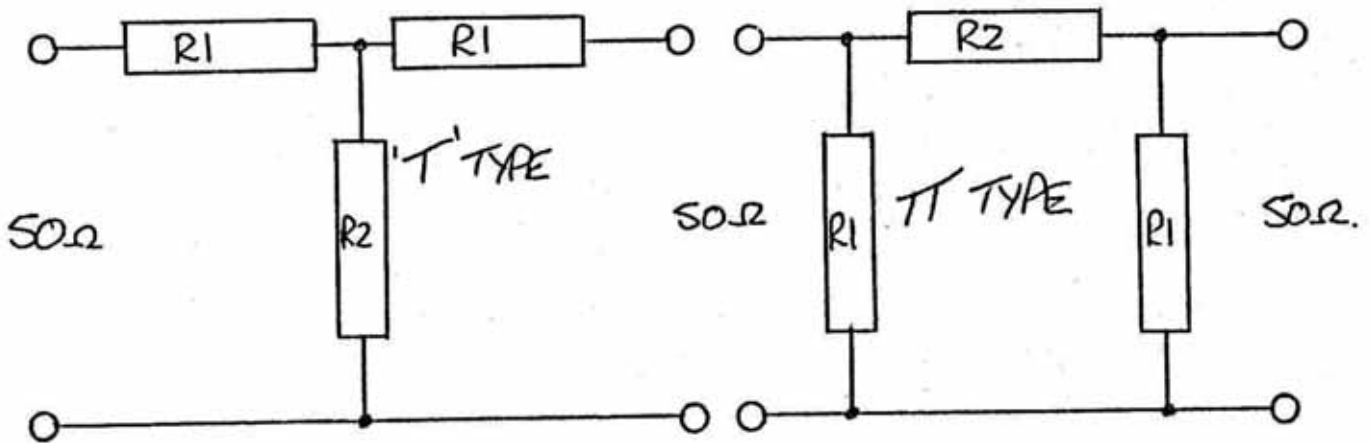

50 Ohm attenuator values  
 T type                  Pi type

dB	R1	R2	R1	R2
1	2.9	433	870	5.8
2	5.7	215	436	11.6
3	8.6	142	292	17.6
4	11.3	105	221	23.9
8	21.5	47.3	116	53
16	36.3	16.3	69	154

N.B.  
 MAXIMUM PRACTICAL LIMIT IS 16dB AT 144MHz DUE TO CAPACITIVE COUPLING. BETTER TWO 16dB STAGES IN SERIES THAN ONE 32dB STAGE



# B. BAMBER ELECTRONICS

COMMUNICATIONS HOUSE  
5 STATION ROAD - LITTLEPORT - CAMBS.  
TEL: ELY (0353) 860185

## ANGLIA INDUSTRIAL AUCTIONS

*Specialist Auctioneers to the Radio & Electronic Industry*

Dear Sir,

Many thanks for your past support at our auctions, we intend to hold auctions in the future at five week intervals this should allow sufficient time for lots to be collected and new lots to be catalogued in time for the next sale.

### THE NEXT SALES WILL BE HELD ON.

Wednesday 18 th August. Entries for cataloguing close on Monday 1 st August.

Wednesday 22 nd September. Entries for cataloguing close on Monday 6 th September.

Wednesday 27 th October. Entries for cataloguing close on Monday 11 th October.

Wednesday 1 st December. Entries for cataloguing close on Monday 15 th November.

Wednesday 12 th Jan. '83. Entries for cataloguing close on Monday 20 th December.

Reference ' Payment of Deposits ' under Notes to Purchases.

On sale day purchasers are not required to conform to this condition as it would cause a delay in the proceedings. However purchasers who wish to give written or phone bids must give sufficient deposit to cover their bids before they can be accepted. Also full payment and collection must be made within 7 days of the sale at the purchaser's expense.

Purchasers who fail to comply with the conditions of sale will be refused admission.

### CATALOGUE DISTRIBUTION & CIRCULATION.

We regret that owing to high postage rates and increasing cost of stationery and print we have to charge for sending out catalogues. The charge for a catalogue to be sent for any one sale will be 60p or for each sale for a year £5.00

European Subscription £6.00

### ENTRY FORMS

Please find enclosed an entry form, further copies are available on application. Although entries for cataloguing may be received up to 17 days before the date of the sale customers are advised to enter early.

Looking forward to seeing you at the next auction.

Yours Faithfully

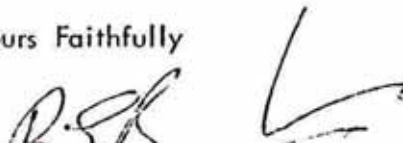

FOR SALE

Dash mounted PYE Cambridge  
6 channel AM/FM switched crystallised  
for S20 S0 R6 with Shure microphone. £ 50. 00. O.N.O.

Contact: Robert Whitfield. G9TSE 051-639-2090.

=====

Sinclair ZX 81 (1K) plus manual and  
games programmes on cassette. £ 42. 50.

Contact: Peter Reardon. G8NQQ. 051-677-9561.

=====

Jaybeam 2 metre groundplane antenna  
Type UGF 2H. £ 2. 50.

Contact: Tom Bates. G4NZS. 051-638-5463.

=====

WANTED

Small handbook/manual for PYE Bantam  
(AM low band).

Dave Owen. G4GGB  
051-648-2163.

=====

Valve type SSB Transmitter for HF,  
any condition.

Also wanted - crystals 8.45 MHz → 8.5 MHz  
and 5.0 MHz → 5.2 MHz  
For ATC use of HF bands.

Bob Williams. G8XEX  
051-342-6955.

## EXTRACT FROM THE RULES OF IRBY CRICKET CLUB

5. CONDUCT

- (a) Any members who wilfully or by gross negligence damages any property of the Club or any property entrusted to the Club shall be liable to make good such damage at his/her own expense. The question of the damage being or not being accidental shall be decided by the Management Committee from such evidence as they may be able to obtain.
- (b) A member may be expelled by resolution of not less than two-thirds of members present at a Special General Meeting duly convened to consider the conduct of such members. No person whose membership has been so terminated shall be introduced by any other member as a visitor to any part of the Club premises.

6. CLUB PREMISES AND BAR

- (a) Any voting member, or lady member, may introduce a guest to the Club premises. Such guest must sign his/her name in a book kept for this purpose and no guest may be introduced to the premises more than six times in any one year.
- (b) Members or visiting teams and their guests and bona fide members of visiting Clubs may purchase intoxicating liquor for consumption on the Club premises on the day or days on which the visiting team plays on the ground.
- (c) No person under 18 years of age shall be permitted to purchase or consume intoxicating liquor on the Club premises.
- (d) Hours of Opening and Closing the Club Premises

Subject to the right of the Management Committee to open and close the Club premises at it's discretion the Club shall be open as follows:-

Weekdays.....	.....	.....	10.00 a.m. to 11.30 p.m.
Sundays	)		
Christmas Day	)..	.....	10.00 a.m. to 11.00 p.m.
Good Friday	)		

Notice of the hours during which the Club premises will be open will be posted in the Clubroom.

(e) Hours of Opening and Closing the Bar

Subject to the right of the Bar Committee to open and close the bar at it's discretion within the permitted hours the bar shall be open as follows:-

Weekdays.....	.....	.....	11.30 a.m. to 2.00 p.m.
			4.00 p.m. to 10.30 p.m.
Sundays	)..	.....	12.00 p.m. to 2.00 p.m.
Christmas Day	)..	.....	7.00 p.m. to 10.30 p.m.
Good Friday	)		

The Bar Committee may on special occasions arrange for the supply of intoxicating liquor at other times subject to legal requirements

Notice of the hours during which the bar will be open will be



WIRRAL AND DISTRICT  
AMATEUR RADIO CLUB

